

Article number: 12308200100110

Description: KLEE-coil 308 200 100.110

M10 Hardened/zinc-plated steel with hexagon

Measures

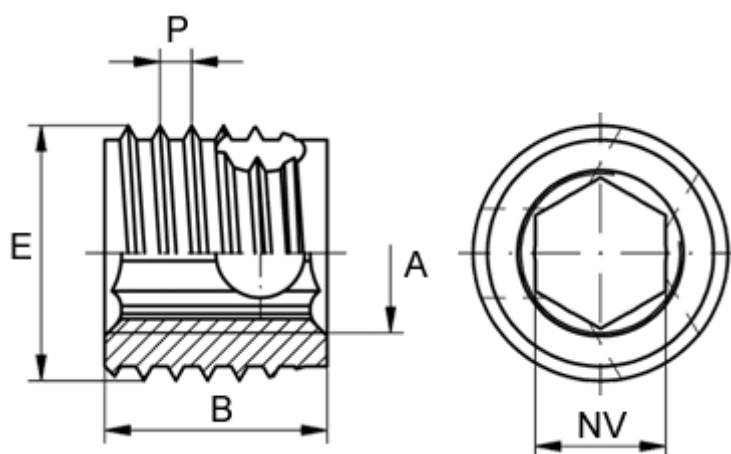

Female thread A	= M10
Length B	= 18
Male thread E	= 14
Min hole depth blind hole	= 22
Min material thickness	= 18
sw	= -
Thread pitch P	= 1.5
Type	= 308 200 100 ...